

**GATE HARDWARE  
CATALOG  
2023-24**





# Regular Residential



Traditional V-notch design suitable for residential use.

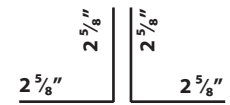

## Regular Residential Hinge Set 90101

- Set of 2 hinges
- Black powder coated stainless steel
- 1 1/2" horizontal adjustment
- 12 sets per case
- Stainless steel mounting screws included

# Special Residential



Built for narrow profile gates. Traditional V-notch design with one leg shorter than the other.

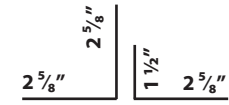
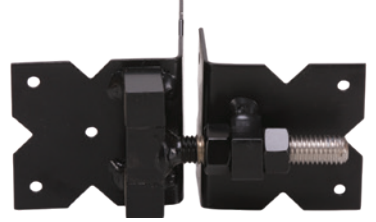

## Special Residential Hinge Set 90102

- Set of 2 hinges
- Black powder coated stainless steel
- 1 1/2" horizontal adjustment
- 24 sets per case
- Stainless steel mounting screws included

# Regular Commercial



Traditional V-notch design specifically built for heavy duty fencing.

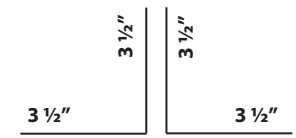
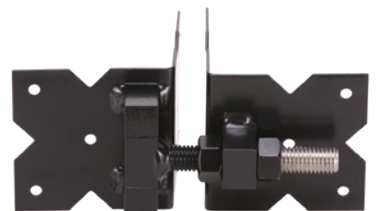

## Regular Commercial Hinge Set 90103

- Set of 2 hinges
- Black powder coated stainless steel
- 1 1/2" Horizontal adjustment
- 10 sets per case
- Stainless steel mounting screws included

# Special Commercial



Built for heavy duty narrow profile gates. Traditional V-notch design with one leg shorter than the other.

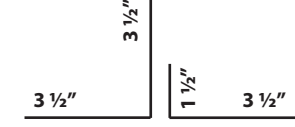
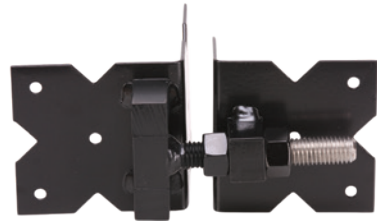

## Special Commercial Hinge Set 90104

- Set of 2 hinges
- Black powder coated stainless steel
- 1 1/2" Horizontal adjustment
- 10 sets per case
- Stainless steel mounting screws included

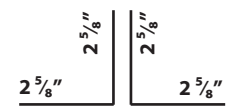

## Regular Residential Latch Set 90201

- Black powder coated stainless steel
- 24 per case
- For left or right hand gate opening
- Padlockable
- Stainless steel mounting screws included



## Special Residential Latch Set 90202

- Black powder coated stainless steel
- 24 per case
- For left or right hand gate opening
- Padlockable
- Stainless steel mounting screws included

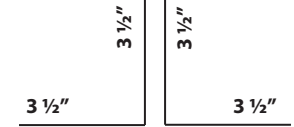

## Regular Commercial Latch Set 90203

- Black powder coated stainless steel
- 12 per case
- For left or right hand gate opening
- Padlockable
- Stainless steel mounting screws included

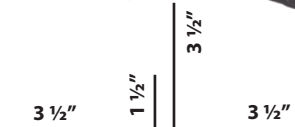

## Special Commercial Latch Set 90204

- Black powder coated stainless steel
- 24 per case
- For left or right hand gate opening
- Padlockable
- Stainless steel mounting screws included

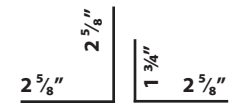

## Regular Residential 2-Way Latch 90301

- Black powder coated stainless steel
- 12 per case
- For left or right hand gate opening
- Padlockable
- Stainless steel mounting screws included

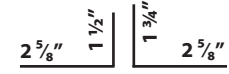

## Special Residential 2-Way Latch 90302

- Black powder coated stainless steel
- 12 per case
- For left or right hand gate opening
- Padlockable
- Stainless steel mounting screws included

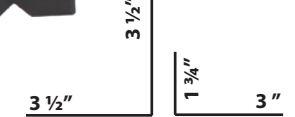

## Regular Commercial 2-Way Latch 90303

- Black powder coated stainless steel
- 12 per case
- For left or right hand gate opening
- Padlockable
- Stainless steel mounting screws included

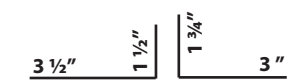

## Special Commercial 2-Way Latch 90304

- Black powder coated stainless steel
- 12 per case
- For left or right hand gate opening
- Padlockable
- Stainless steel mounting screws included

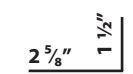

## Residential Drop Pin 90401

- Black powder coated stainless steel
- Stainless steel mounting screws included
- 24" drop pin

**“ I use Depend-a-Bull Hardware exclusively in all of my construction projects, and my customers never had a problem with these products. ”**

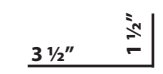

## Commercial Drop Pin 90403

- Black powder coated stainless steel
- Stainless steel mounting screws included
- 34" drop pin

*Just because your business serves the public, doesn't mean you want them in every square foot of your property. Depend-a-Bull's Regular Commercial Hinge, Latch, & Drop Pin Kit gives your staff easy access while discouraging unwanted guests.*

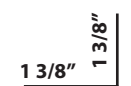

## Drop Rod 34" 90401-34

## Drop Rod 46" 90401-46

- Black powder coated stainless steel
- Stainless steel mounting screws included
- 34" or 46"

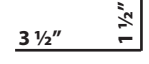
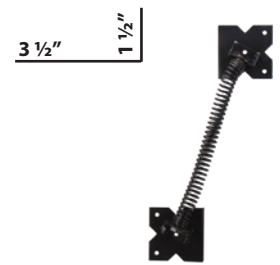

## Commercial Spring Set 90503

- Black powder coated stainless steel
- Stainless steel mounting screws included



# Select



Contemporary-style hardware with the same strength as our traditional V-notch design. (Residential components on commercial size hardware.)

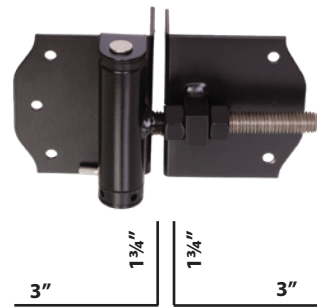

## Select Spring Hinge Set 90905

- Set of 2 hinges
- Black powder coated stainless steel
- 1 1/2" horizontal adjustment
- 12 sets per case
- Stainless steel mounting screws included

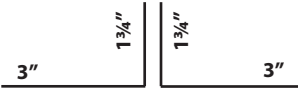

# Aluminum Rail

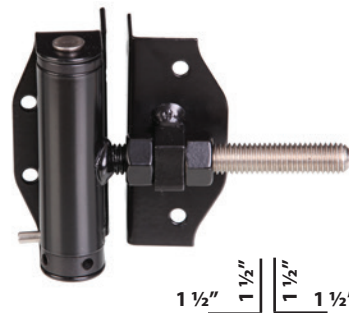

## Alum Rail Spring Hinge Set 90906

- Set of 2 hinges
- Black powder coated stainless steel
- 1 1/2" horizontal adjustment
- 12 sets per case
- Stainless steel mounting screws included

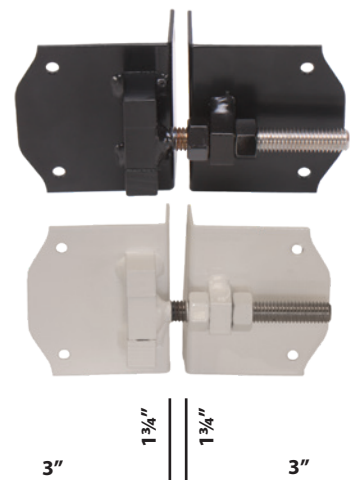
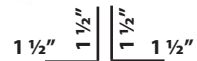

## Select Hinge Set Black 90105 White 91105

- Set of 2 hinges
- Black or white powder coated stainless steel
- 1 1/2" horizontal adjustment
- 12 sets per case
- Stainless steel mounting screws included

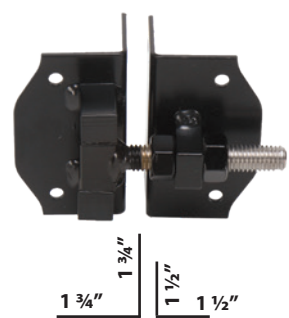
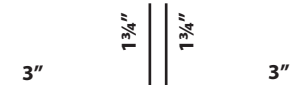

## Alum Rail Hinge Set 90106

- Set of 2 hinges
- Black powder coated stainless steel
- 1 1/2" horizontal adjustment
- 12 sets per case
- Stainless steel mounting screws included

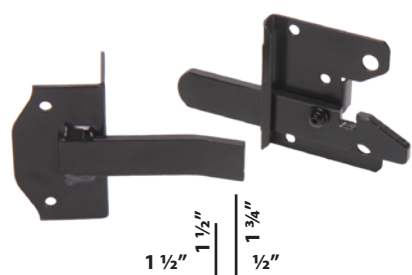
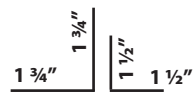

## Alum Rail 2-Way Latch 90306

- Black powder coated stainless steel
- 12 per case
- For left or right hand gate opening
- Padlockable
- Stainless steel mounting screws included

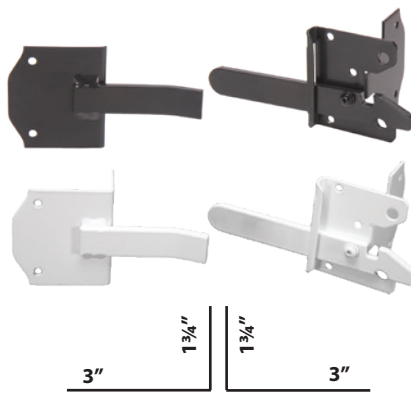
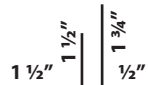

## Select 2-Way Latch Set Black 90305 White 91305

- Black or white powder coated stainless steel
- 12 per case
- For left or right hand gate opening
- Padlockable
- Stainless steel mounting screws included

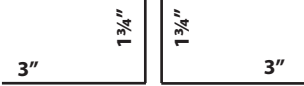

# Gate Handles



## Gate Handles Black 90600 White 91600

- Black or white powder coated aluminum
- Stainless steel mounting screws included

# "U" Commercial



3-sided hinges & gate wheels.

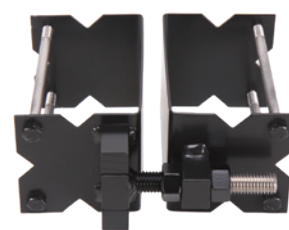

## 5" U Commercial Hinge Set 90109

- Set of 2 hinges
- Black powder coated stainless steel
- 1 1/2" horizontal adjustment
- Fits 5" post
- 10 per case
- Stainless steel mounting bolts included

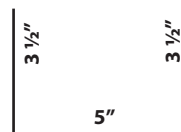

## 5" U Commercial Latch 90209

- Black powder coated stainless steel
- 10 per case
- For left or right hand gate opening
- Padlockable
- Stainless steel mounting bolts included

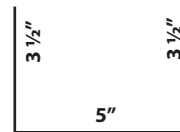

# Gate Wheels



## 5" Gate Wheels 90709

- Black powder coated stainless steel
- 10 per case
- Stainless steel mounting bolts included

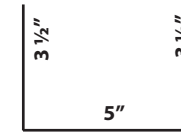

## 4" Gate Wheels 90708

- Black powder coated stainless steel
- 10 per case
- Stainless steel mounting bolts included

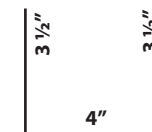

# Post Mounts



## 4" Double Plate Post Mount 89042

- 36" tall
- Galvanized
- Hardware included
- Easy to level leveling plate
- Molded spacers shaped to fit 4" design posts

(Assembled)



(Contents of kit)

## 4" Single Plate Post Mount 89041

- 36" tall
- Galvanized
- Hardware included
- Easy to level leveling plate
- Molded spacers shaped to fit 4" design posts



## 5" Single Plate Post Mount 89051

- 42" tall
- Galvanized
- Hardware included
- Easy to level leveling plate
- Molded spacers shaped to fit 5" design posts



## 6" Single Plate Post Mount 89061

- 42" tall
- Galvanized
- Hardware included
- Easy to level leveling plate
- Molded spacers shaped to fit 6" design posts



## Select / Alum Rail Drop Rod Kit

- Black 90405-34 90405-46
- White 91405-34 91405-46

- Black or white powder coated stainless steel
- Stainless steel mounting screws included
- 34" or 46" drop rod



“ ...I will not use cheaper materials. If a gate comes with another brand of hinge, I replace it with the Depend-a-Bull. ”





# Hardware Numbering System

**8 = Post Mount**  
**9 = Gate Hardware**

**Color:**  
**0 = Black**  
**1 = White**  
**9 = Galvanized**

**9 0 1 0 3**

**1 = Hinge**      **6 = Gate Handle**  
**2 = Latch**      **7 = Gate Wheels**  
**3 = 2 Way Latch**      **8 = 2 Way Lock**  
**4 = Drop Pin/Rod**      **9 = Spring Hinge**  
**5 = Spring Set**

**00 = Neutral**      **08 = 4" U Commercial**  
**01 = Residential**      **09 = 5" U Commercial**  
**02 = Special Residential**      **41 = 4" Single Plate**  
**03 = Commercial**      **42 = 4" Double Plate**  
**04 = Special Commercial**      **51 = 5" Post Mount**  
**05 = Select**      **61 = 6" Post Mount**  
**06 = Aluminum Rail**

## Manufacturing Quality Products in a Picturesque Village

Welcome to our charming village of Bird-in-Hand, Pennsylvania. Ever since the Quakers, Mennonites, and Amish settled this land in colonial times, our community has been alive with trades and crafts as well as farming.

Stagecoaches and freight wagons stopped for the night in our village as they rumbled along the Old Philadelphia Pike on their way from Philadelphia to Lancaster. Local inns and other places of commerce sprang up to service these freight haulers who were helping to build a new country.

Today along the tree-lined village street called Maple Avenue, our Stoltzfus family is practicing the trade of manufacturing metal gate hardware for use with vinyl fencing. We carry on the fine tradition of quality craftsmanship for which our Lancaster County community is well known.

Along with the other businesses in our village, we desire to provide our industry with the best products possible at the fairest price. That is the way we do business in Bird-in-Hand.

We are blessed to be a part of this community where integrity and honesty are a part of daily commerce. Our hinges and latches are truly Lancaster County-made!

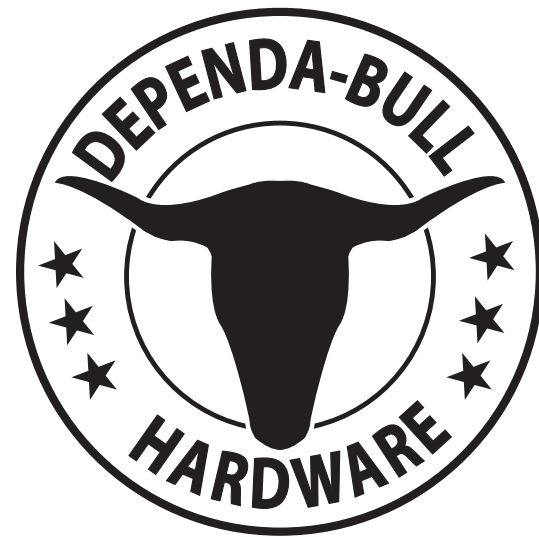

717-397-4079 (phone) 717-397-4085 (fax)  
250 Maple Avenue Bird-In-Hand, PA 17505

**GATE HARDWARE ORDER FORM**  

SOLD TO: \_\_\_\_\_ SHIP TO: \_\_\_\_\_  
 \_\_\_\_\_  
 \_\_\_\_\_  
 PO #: \_\_\_\_\_ PHONE: \_\_\_\_\_ EMAIL: \_\_\_\_\_

Sales Person	Date Ordered	Ship Date	Via Motor Freight	Packed By	Billed By	
		Call/	PU / D / UPS			
Sets per skid	Item Number	Case #	Description	Price	Qty	Total
528	90101	12	Regular Residential Hinge Set		x	=
864	90201	24	Regular Residential Latch Set			
432	90301	12	Regular Residential 2 Way Latch Set			
216	90401	1	Residential Drop Pin Kit			
	90401-34	10	Residential Drop Rod Kit - 34"			
	90401-46	10	Residential Drop Rod Kit - 46"			
528	90102	12	Special Residential Hinge Set			
846	90202	24	Special Residential Latch Set			
432	90302	12	Special Residential 2 Way Latch Set			
280	90103	10	Regular Commercial Hinge Set			
432	90203	12	Regular Commercial Latch Set			
432	90303	12	Regular Commercial 2 Way Latch Set			
99	90403	1	Commercial Drop Pin Kit			
252	90503	1	Commercial Spring Set			
280	90104	10	Special Commercial Hinge Set			
432	90204	24	Special Commercial Latch Set			
360	90304	12	Special Commercial 2 Way Latch Set			
99	90403	1	Commercial Drop Pin Kit			
432	90905	12	Select Spring Hinge			
432	91105	12	Select Hinge Set (white)			
432	90105	12	Select Hinge Set (black)			
432	91305	12	Select 2 Way Latch Set (white)			
432	90305	12	Select 2 Way Latch Set (black)			
	91405-34	10	Select / Alum Rail Drop Rod Kit (white) - 34"			
	91405-46	10	Select / Alum Rail Drop Rod Kit (white) - 46"			
	90405-34	10	Select / Alum Rail Drop Rod Kit (black) - 34"			
	90405-46	10	Select / Alum Rail Drop Rod Kit (black) - 46"			
432	90906	12	Alum Rail Spring Hinge			
432	90106	12	Alum Rail Hinge			
432	90306	12	Alum Rail 2 Way Latch			
	90109	10	5" U Commercial Hinge Set			
	90209	10	5" U Commercial Latch			
	90708	10	4" Gate Wheels			
	90709	10	5" Gate Wheels			
	91600	100	Gate Handle (white)			
	90600	100	Gate Handle (black)			
90	89041		4" Single Plate Post Mount			
90	89042		4" Double Plate Post Mount			
56	89051		5" Single Plate Post Mount			
49	89061		6" Single Plate Post Mount			

Signature \_\_\_\_\_ Date \_\_\_\_\_





250 Maple Avenue  
Bird-in-Hand, PA 17505  
717-397-4079

## Top 10 Reasons to Install

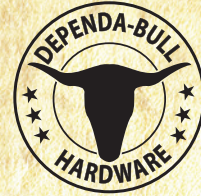

**1.** Our products are solely **manufactured in the USA**, truly Lancaster County-made.

**2.** Our products are **all season**, designed for use in areas with high and low temperatures.

**3.** All of our hardware components are made of metal, specifically **stainless steel**.

**4.** We produce hardware that is **rust proof and withstands moisture**.

**5.** The test of time has proven our products to be **heavy duty**.

**6.** We pack right off of the line, **preventing scratches & eliminating dust**.

**7.** The **L bracket / V-notch design originated at our company**.

**8.** Our threaded stud makes **fine tuning quick & easy**.

**9.** The look of our hardware is **traditional and timeless**, fitting perfectly with the fencing.

**10.** Our hardware endures a **rigorous 8-stage pre-treatment process** to properly prepare the steel for maximum coating adhesion.

